



Digital Projector

User Manual

Portable Series | GV10

V 1.00

Product support

This document aims to provide the most updated and accurate information to customers, and thus all contents may be modified from time to time without prior notice. Please visit the website for the latest version of this document and other product information. Available files vary by model.

1. Make sure your computer is connected to the Internet.
2. Visit the local website from Support.BenQ.com. The website layout and content may vary by region/country.

Search for your model's user manual and related document.

Servicing

- If misuse or other accident occurs, contact qualified service personnel for servicing.
- Contact your place of purchase or visit the local website from Support.BenQ.com for more support.



Support.BenQ.com

Q&A Index

Start with the topics you are interested in:

Setup

How do I set up the projector and turn it on?

Choosing a location	19
Operations	21

Image Adjustment

How do I adjust the focus of the projected image?

Adjusting the projection angle	24
Fine-tuning the image clarity	25
Correcting keystone	26

Usage

How to project wirelessly?

Connecting a dongle	28
---------------------	----

How do I play music via the projector?

Connecting audio	30
------------------	----

Maintenance and Product Support

What should I do if I don't plan to use the projector for a long time?

Storing the projector	36
-----------------------	----

Table of contents

Product support	2
Servicing	2
Q&A Index	3
Package contents	10
Standard accessories	10
Introduction	12
Projector exterior view.....	12
Front, top, and left side view.....	12
Rear, bottom, and right side view	13
Dimensions	14
LED indicators	15
Remote control	16
Installing/Replacing the remote control batteries.....	17
Remote control effective range	18
Installation	19
Choosing a location.....	19
Operations	21
Charging the battery	21
Starting up the projector	22
Shutting down the projector	23
Adjusting the projected image	24

Adjusting the projection angle.....	24
Fine-tuning the image clarity	25
Correcting keystone	26
Connections	27
Wired connections.....	28
Connecting a device with HDMI.....	28
Switching input sources	29
Connecting a USB flash drive.....	30
Connecting audio.....	30
Navigating the settings menu	31
About the settings menu	31
Using the Settings menu.....	32
Picture & Sound	33
Installation	34
System	35
Maintenance	36
Care of the projector	36
Cleaning the lens.....	36
Storing the projector	36
Transporting the projector	37
Extending LED life	37
Troubleshooting	38
Specifications	40
Projector specifications	40
Timing chart.....	42
Supported file formats.....	45

Appendix	46
Installing the projector on a tripod (purchased separately).....	46
Copyright and disclaimer	47
Copyright.....	47
Disclaimer	47
Warranty.....	47
Statement regarding hyperlinks and third-party websites	48

Important safety instructions

Your projector is designed and tested to meet the latest standards for safety of information technology equipment. However, to ensure safe use of this product, it is important that you follow the instructions mentioned in this manual and marked on the product.

1. Please read this user manual before you operate your projector.
Keep this manual in a safe place for future reference.

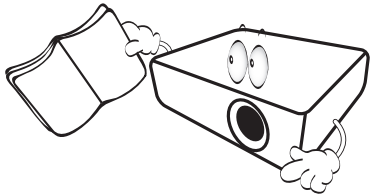

2. Always place the projector on a level, horizontal surface during operation.
 - Do not place the projector on an unstable cart, stand, or table as it may fall and be damaged.
 - Do not place inflammables near the projector.
 - Do not use if tilted at an angle of more than 10 degrees left to right, nor at angle of more than 15 degrees front to back.

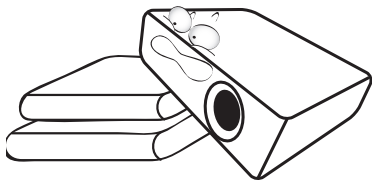

3. Do not store the projector on end vertically. Doing so may cause the projector to fall over, causing injury or resulting in damage.

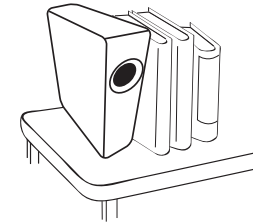

4. Do not place the projector in any of the following environments:
 - Space that is poorly ventilated or confined. Allow at least 50 cm clearance from walls and free flow of air around the projector.
 - Locations where temperatures may become excessively high, such as the inside of a car with all windows closed.
 - Locations where excessive humidity, dust, or cigarette smoke may contaminate optical components, shorten the projector's lifespan and darken the screen.

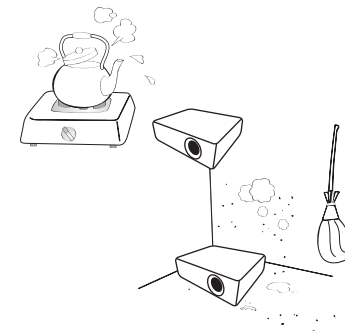

- Locations near fire alarms.
- Locations with an ambient temperature above 40°C/104°F.

- Locations where the altitudes are higher than 1500 m (4921 feet).

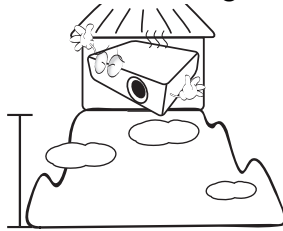

5. Do not block the vents holes while the projector is on (even in power-saving mode).

- Do not cover the projector with any item.
- Do not place the projector on a blanket, bedding or any other soft surface.

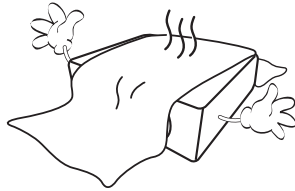

6. In areas where the mains power supply voltage may fluctuate by ± 10 volts, it is recommended that you connect the projector through a power stabilizer, surge protector or uninterruptible power supply (UPS) as appropriate to your situation.

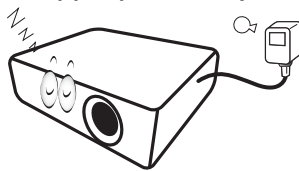

7. Do not step on the projector or place any objects upon it.



8. Do not place liquids near or on the projector. Liquids spilled into the projector will void your warranty. If the projector does become wet, disconnect it from the power point and call BenQ to have the projector repaired.

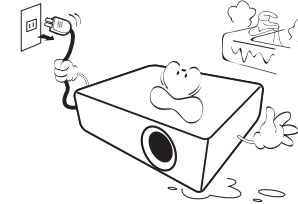

9. Do not look straight into the projector lens during operation. It may harm your sight.

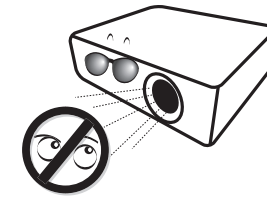

10. Do not operate the projector LED beyond the rated LED life. Excessive operation of LEDs beyond the rated life could cause LEDs to break on rare occasions.

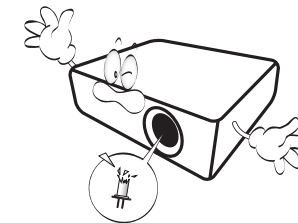

11. This projector is capable of displaying inverted images for ceiling installation.

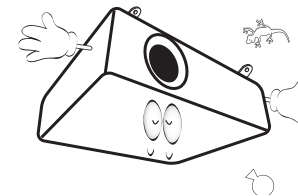

12. Do not attempt to disassemble this projector. There are dangerous high voltages inside which may cause death if you should come into contact with live parts.

Under no circumstances should you ever undo or remove any other covers. Refer servicing only to suitably qualified professional service personnel.

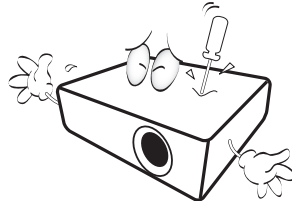

- !** Please keep the original packing for possible future shipment. If you need to pack your projector after use, adjust the projection lens to an appropriate position, put the lens cushion around the lens, and fit the lens cushion and projector cushion together to prevent damage during transportation.

13. When you think service or repair is required, take the projector only to a suitably qualified technician.

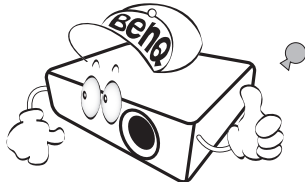

Moisture condensation

Never operate the projector immediately after moving it from a cold location to a hot location. When the projector is exposed to such a change in temperature, moisture may condense on the crucial internal parts. To prevent the projector from possible damage, do not use the projector for at least 2 hours when there is a sudden change in temperature.

Avoid volatile liquids

Do not use volatile liquids, such as insecticide or certain types of cleaner, near the projector. Do not have rubber or plastic products touching the projector for a long time. They will leave marks on the finish. If cleaning with a chemically treated cloth, be sure to follow the cleaning product's safety instructions.

Disposal

This product contains the following materials which are harmful to human bodies and environment.

- Lead, which is contained in solder.

To dispose of the product, consult your local environment authorities for regulations.

- !** The illustrations and the images shown in this document are for your reference. The actual content may vary by the product supplied for your region.

Package contents

Carefully unpack and verify that you have the items below. Some of the items may not be available depending on your region of purchase. Please check with your place of purchase.

Standard accessories

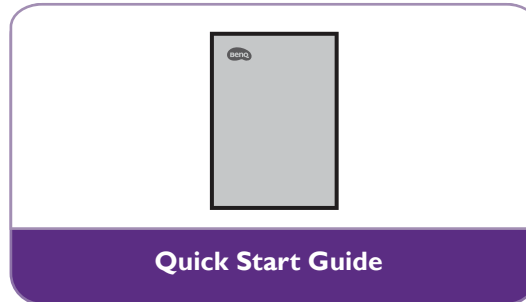
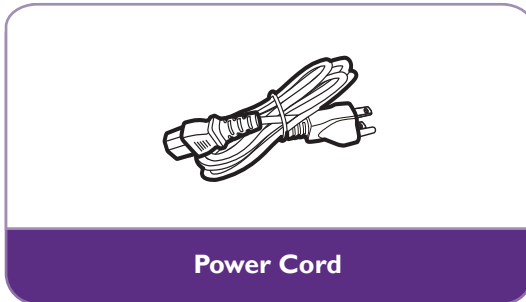
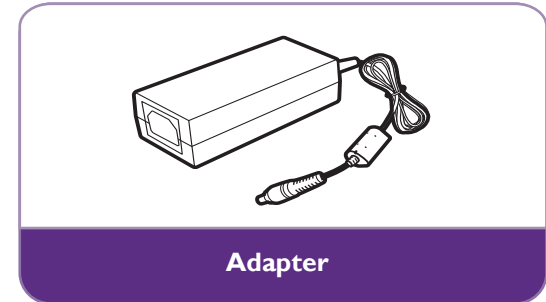
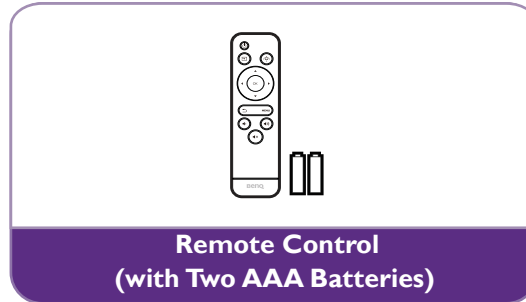
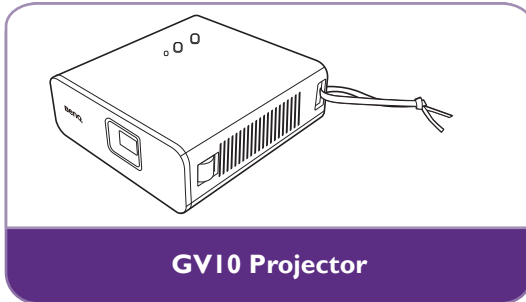

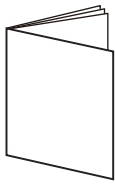

Regulatory Statements



-
- LED life results will vary depending on environmental conditions and usage. Actual product's features and specifications are subject to change without notice.
 - Some of the accessories may vary from region to region.
 - The warranty card is only supplied in some specific regions. Please consult your dealer for detailed information.
 - For AC/DC adapter, the socket-outlet shall be installed near the equipment and shall be easily accessible.
 - Use original accessories to ensure compatibility.
 - Power cord plug type may change based on regional requirements.
-

Introduction

Projector exterior view

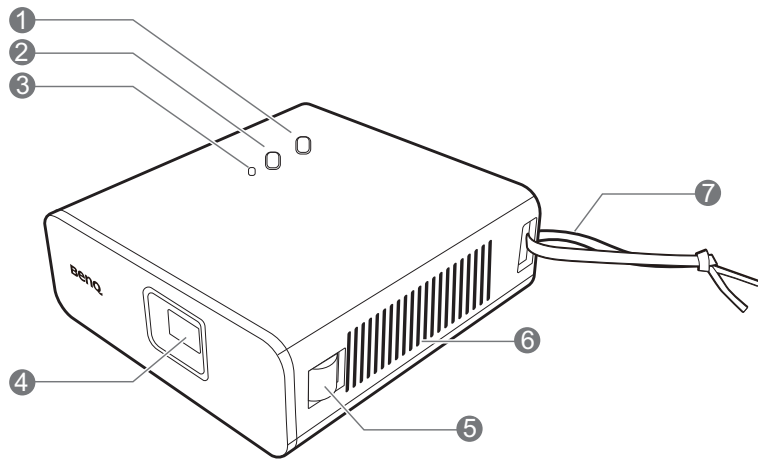
Front, top, and left side view



1.  **Volume down button**
2.  **Volume up button**
3. **LED**
See [LED indicators on page 15](#) for details on the LED behavior.
4. **Projection lens**
5. **Focus ring**
See [Fine-tuning the image clarity on page 25](#) for more details.
6. **Speaker**
7. **Strap**

Rear, bottom, and right side view

See [Connections on page 27](#) for connection details.

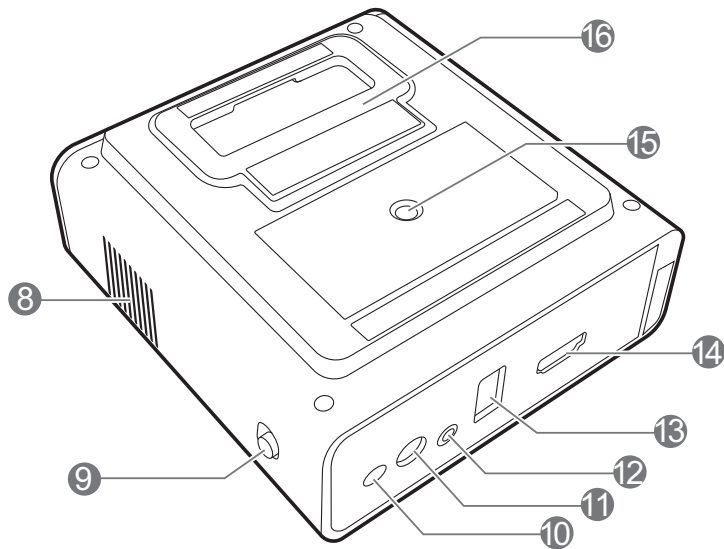

8. Vent (air exhaust)

9. Power switch

Turns the projector on and off. See [LED indicators on page 15](#) for more details.

10. IR sensor

11. Power adapter port

Used to connect the power adapter.



Please only use the supplied power adapter to avoid possible dangers such as electric shock and fire.

12. 3.5" audio output jack

Used to connect headphones, speakers, and other equipment to broadcast audio.

13. USB-A 2.0 port

Used to connect a USB flash drive to project/broadcast media stored on the device.



The USB-A port is able to provide power (5V, 2.0A) to connected devices.

14. HDMI port (Version 1.4b)

Used to connect video sources that support the HDMI interface.

Used to connect a compatible Wi-Fi dongle (purchased separately) that supports the HDMI interface.

15. Tripod screwhole

Used to attach a tripod plate to mount the projector on a tripod. See [Installing the projector on a tripod \(purchased separately\) on page 46](#) for details.

16. Collapsible stand

Open it to adjust the projection angle. See [Adjusting the projection angle on page 24](#) for more details.

Dimensions

112 (W) x 44.5 (H) x 116.8 (D) mm

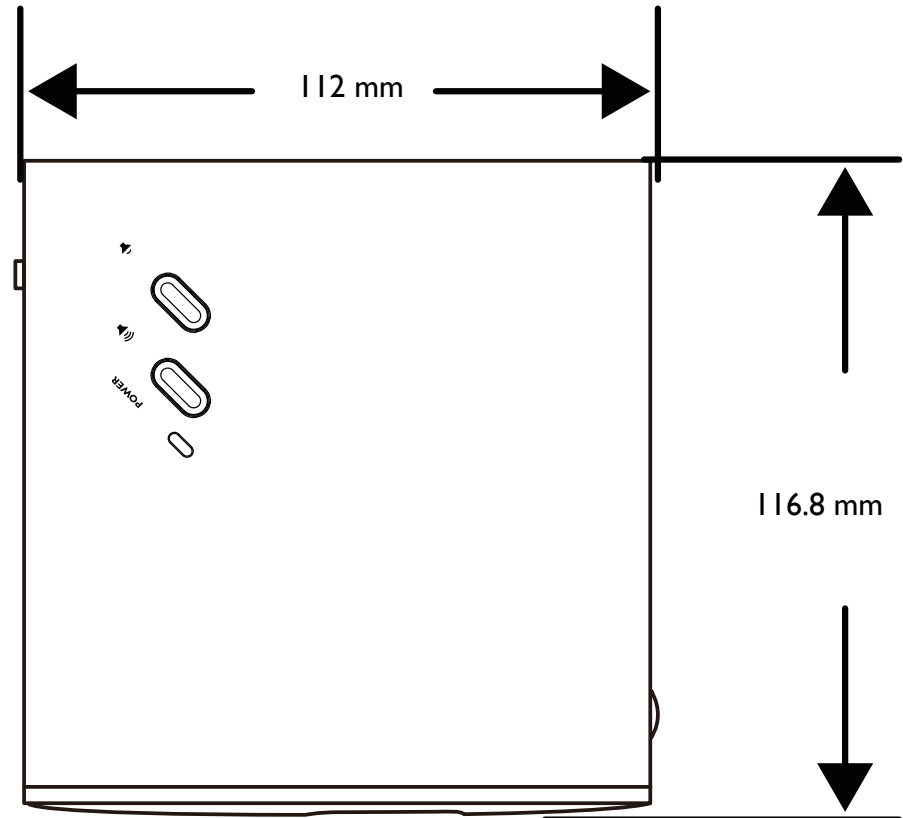
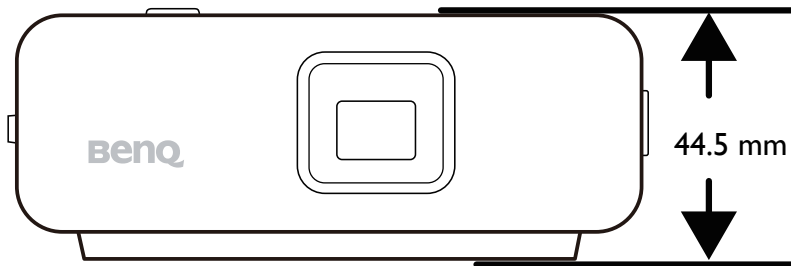

LED indicators

There is a multi-color power LED at the top of the projector.

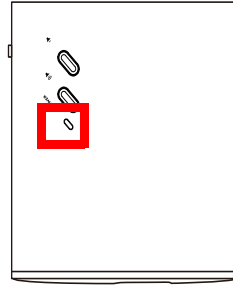









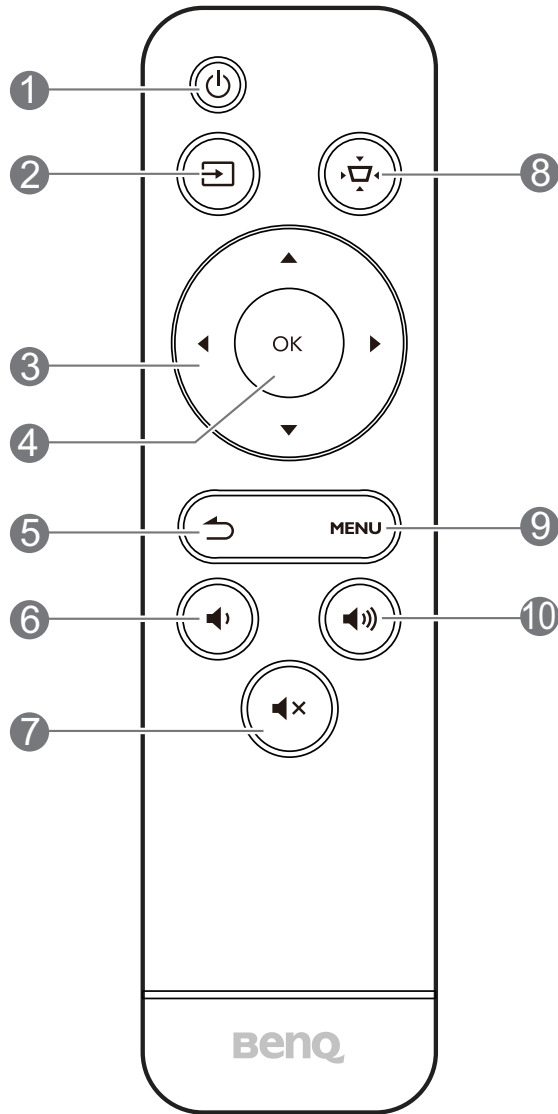



Refer to the table below for definitions of various LED behaviors.

Scenario	Status	Power LED indicator behavior
Switched on & powered on	Battery capacity: 0 - 100%	Green - solid
	(Adapter plugged in) Battery charging	Red - solid
	(Adapter plugged in) Battery fully charged or not charging	Green - solid
Switched on & powered off	Battery capacity: 0 - 100%	Off
	(Adapter plugged in) Battery charging	Red - solid
	(Adapter plugged in) Battery fully charged or not charging	Green - solid
Switched off	Battery capacity: 0 - 100%	Off
	(Adapter plugged in) Battery charging	Red - solid
	(Adapter plugged in) Battery fully charged or not charging	Off
Error*	Fan error & temperature error	Red/Orange - flashing
		Green - flashing

*Restart the projector if there are any errors.

Remote control





- 1.  Power**
Turns the projector off and on.
- 2.  Source**
Opens the input source menu.
- 3. **Arrow buttons** ( Left,  Right,  Up,  Down)**
Used as navigation buttons to select the desired menu items and to make adjustments.
- 4. **OK****
Used to confirm selections.
- 5.  Back**
Returns to the previous menu.
- 6.  Volume Down**
Decreases the projector volume.
- 7.  Mute**
Mutes the projector's audio.
- 8.  Keystone**
Adjusts the keystone settings for the projector. See [Correcting keystone on page 26](#) for more details.
- 9. **MENU****
Launches the projector's on-screen settings menu.
- 10.  Volume Up**
Increases the projector volume.

Installing/Replacing the remote control batteries

Before you can begin to use the remote control, you must install the supplied batteries into the remote control.

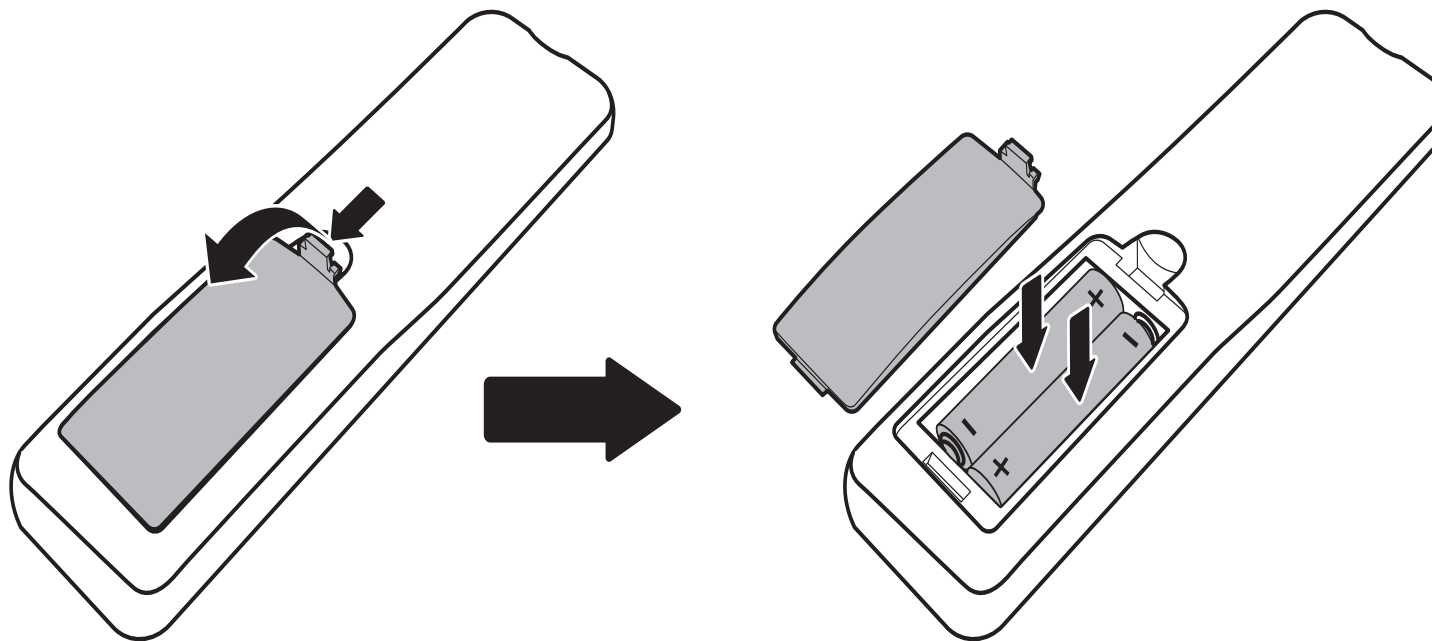
1. Push down on the tab on the battery cover and pull the tab away from the remote control to remove the battery cover.
2. Insert the batteries in the orientation shown below.
3. Place the battery cover back onto the remote control until it clicks into position.



 Avoid leaving the remote control and battery in an excessively hot or humid environment like the kitchen, bathroom, sauna, sunroom or in a closed car.

Remote control effective range

The projector has one IR remote control sensor located at the rear of the projector with a range of 8 meters (~26 feet) at an angle of 30 degrees (left and right). Make sure that there are no obstacles between the remote control and the IR sensor on the projector.

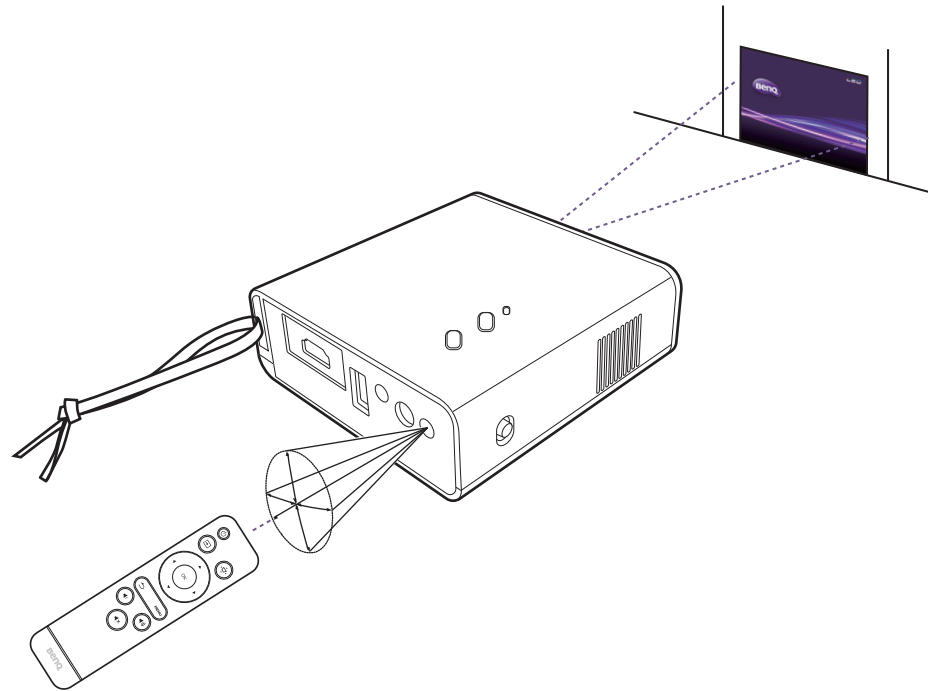

Installation

Choosing a location

Before choosing an installation location for your projector, take the following factors into consideration:

- Size and position of your screen
- Electrical outlet location
- Location and distance between the projector and the rest of your equipment
- Location and distance between the projector and the wireless access point

You can install your projector in the following ways:

1. Front Table:

Select this location with the projector placed near the floor in front of the screen.

This is the most common way to position the projector for quick setup and portability.

Turn on the projector and select the following settings in the projector's settings menu. See for [Installation on page 34](#) more details:

Installation > Projector Position > Front Table

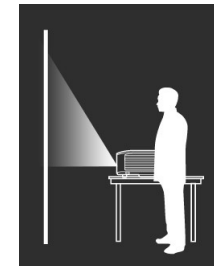

2. Front Ceiling:

Select this location with the projector elevated near the ceiling in front of the screen.

Turn on the projector and select the following settings in the projector's settings menu. See for [Installation on page 34](#) more details:

Installation > Projector Position > Front Ceiling

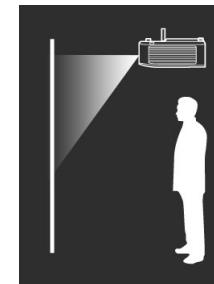

The projector does not feature ceiling mount components/equipment so when choosing to use a front ceiling location you must place it on an elevated location of your choice.

3. Rear Table:

Select this location with the projector placed near the floor behind the screen.

Turn on the projector and select the following settings in the projector's settings menu. See for [Installation on page 34](#) more details:

Installation > Projector Position > Rear Table



A special rear projection screen is required.

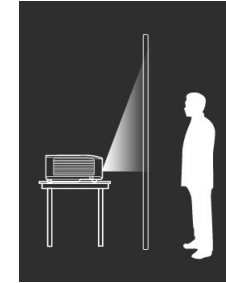

4. Rear Ceiling:

Select this location with the projector elevated from the ceiling behind the screen.

Turn on the projector and select the following settings in the projector's settings menu. See for [Installation on page 34](#) more details:

Installation > Projector Position > Rear Ceiling



A special rear projection screen is required.



The projector does not feature ceiling mount components/equipment so when choosing to use a rear ceiling location you must place it on an elevated location of your choice.

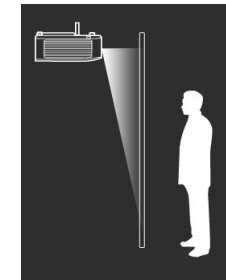

Operations

Charging the battery

1. Connect the adapter to the power adapter port.
2. Connect the power cord to the power adapter.
3. Connect the power cord to a power outlet. Charge the projector for up to 2 hours before turning it on for the first time, or charge the projector for up to 4 hours during the first usage. The power LED indicator will illuminate according to its charge status, for a full charge wait until the indicator turns green or off (see [LED indicators on page 15](#) for more information on LED behavior).

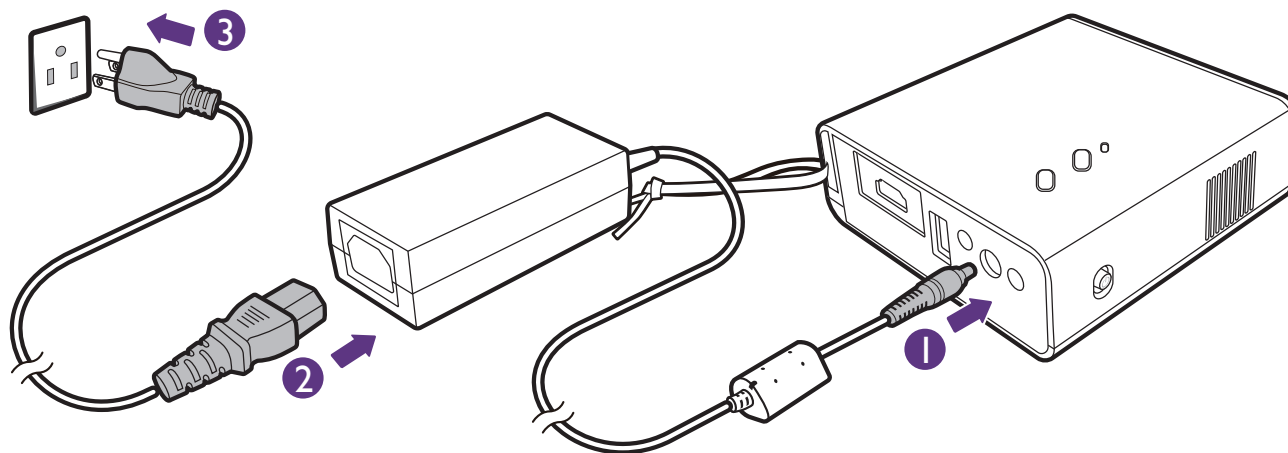

When charged, the projector is able to supply power via its USB-A (5V, 2A) port.

Starting up the projector

1. Charge the battery or supply power to the projector as indicated in [Charging the battery on page 21](#).
2. For first time usage, before turning on the projector, ensure that the power cord is securely connected. Charge the projector for up to 2 hours before turning it on for the first time, or charge the projector for up to 4 hours during the first usage (see [LED indicators on page 15](#) for more information on LED behavior).
3. Push the power switch up on the right side of the projector. The Power indicator LED will light up and you can start using the projector.
4. As long as the power switch remains on, you can use the power button  on the remote control to turn the projector on or off. If you will not be using the projector for an extended period of time, switch the power off to save power.

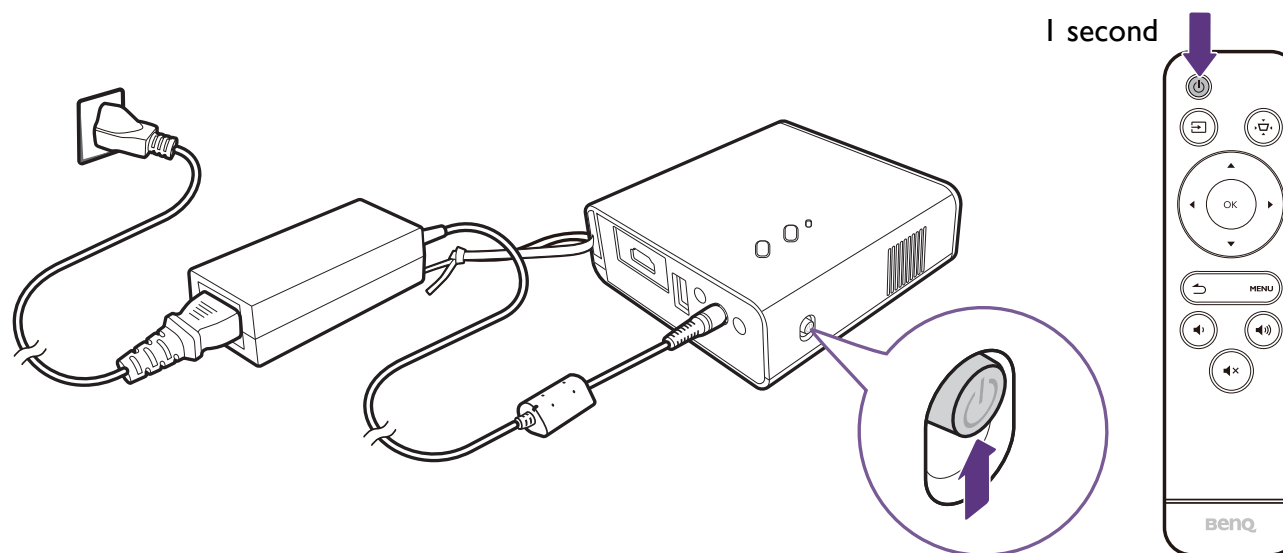

 When supplying power directly to the projector please use the supplied power cable to avoid possible dangers such as electric shock and fire.

5. The fans will start operating and a start-up image will be shown while the projector warms up. This process may take a few minutes. The projector does not respond to further commands while it is warming up.
6. You may connect a device to the projector to project video. See [Connections on page 27](#) for more information.

Shutting down the projector

1. Press the power button  on the remote control. The projector will display a power mode message. Choose **Power Off** if you wish to turn the projector off. Or you can push the power button down on the projector to completely shut down the projector.
2. The power LED will turn off, red or green (depending on the battery status) (see [LED indicators on page 15](#)). The fans may continue to run in order to cool the system.

If the projector will not be used for an extended period, switch off the projector, unplug the power cable from the power outlet and remove the batteries from the remote control.

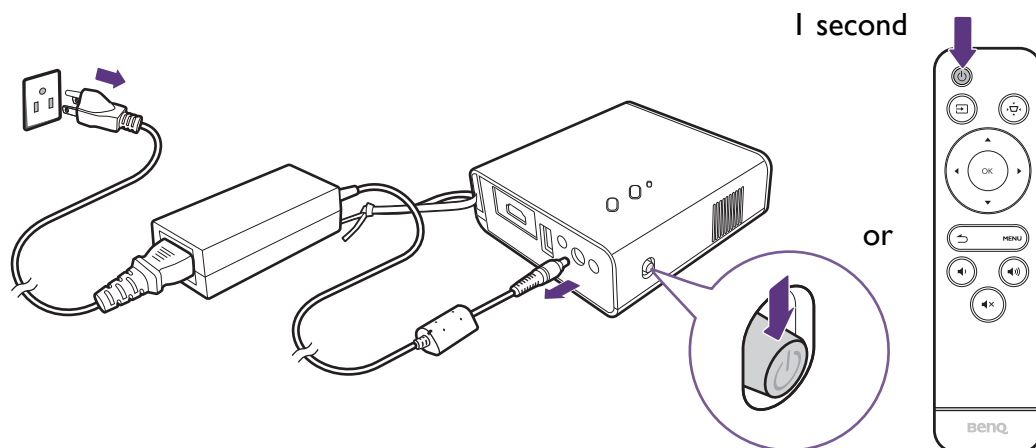

Adjusting the projected image

Adjusting the projection angle

The projector features a collapsible stand that allows you to adjust the projection angle.

To adjust the projection angle:

- Open the stand to raise the image to the desired height and angle.
- To retract the stand, hold up the projector while closing the stand, then slowly lower the projector.

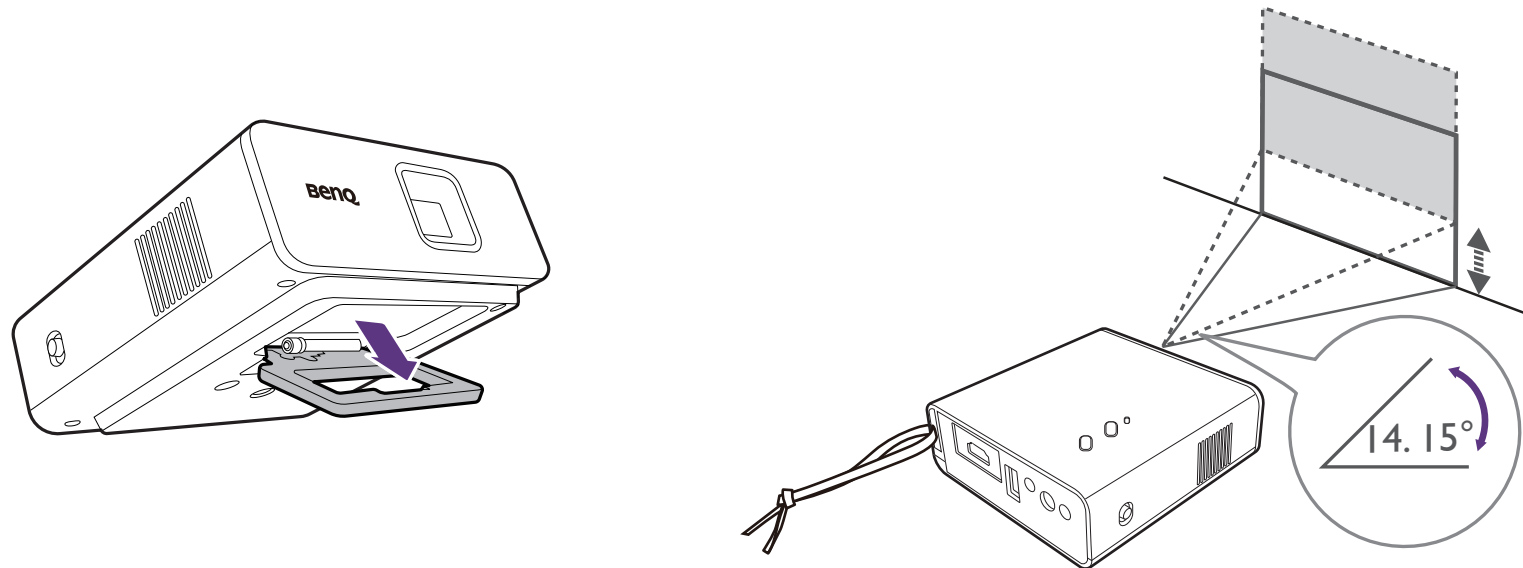

-
-  The maximum angle of adjustment is 14.15 degrees.
 - If the screen and the projector are not perpendicular to each other, the projected image becomes trapezoidal. To correct this, see [Correcting keystone on page 26](#) for details.
-

Fine-tuning the image clarity

To sharpen the picture, turn the focus ring on the left side of the projector.

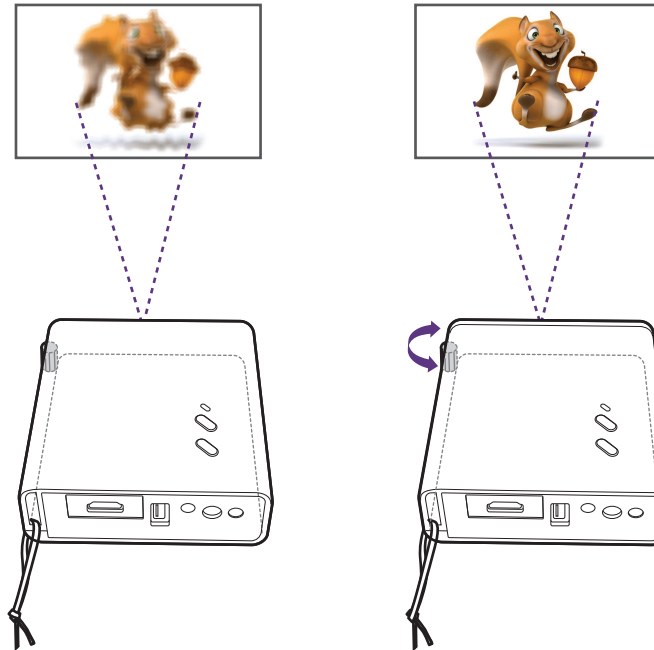

Do not look into the lens while the light is on. The strong light from the light may cause damage to your eyes.

Correcting keystone

The keystone effect refers to the situation where the projected image is noticeably wider at the top / bottom. It occurs when the projector is not perpendicular to the screen. To correct the keystone effect press the keystone button  on the remote control and then follow the on-screen instructions to make the adjustments.

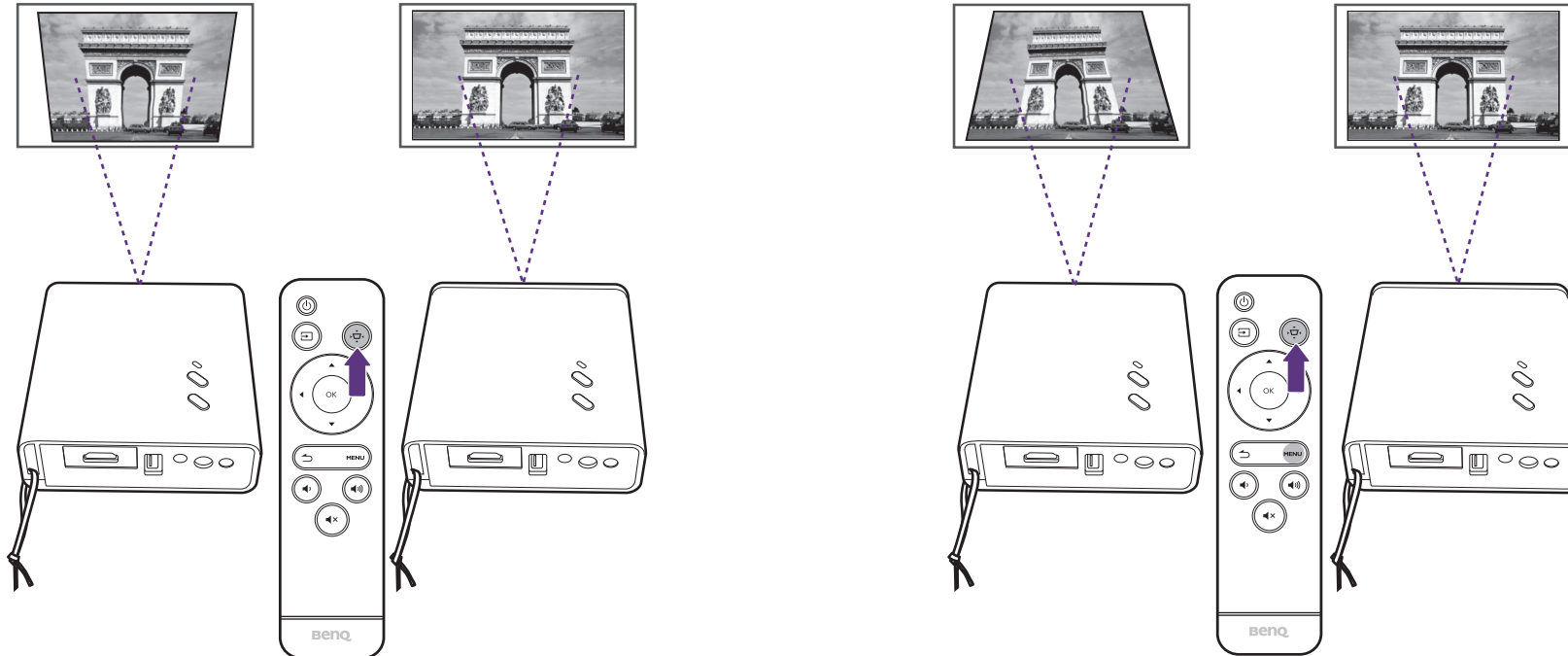

When you are done making the adjustments, press  to save your changes and return to the previous menu.

Connections

You can connect your device to the projector in various ways to project video content.

Wired Connection (HDMI port)

- A/V device.
- Smartphone, tablet, laptop/PC, dongle

Wired Connection (USB-A port)

- USB-A flash drive

Before making any wired connections, be sure to:

- Use the correct cables for each source and make sure the cables are firmly inserted.

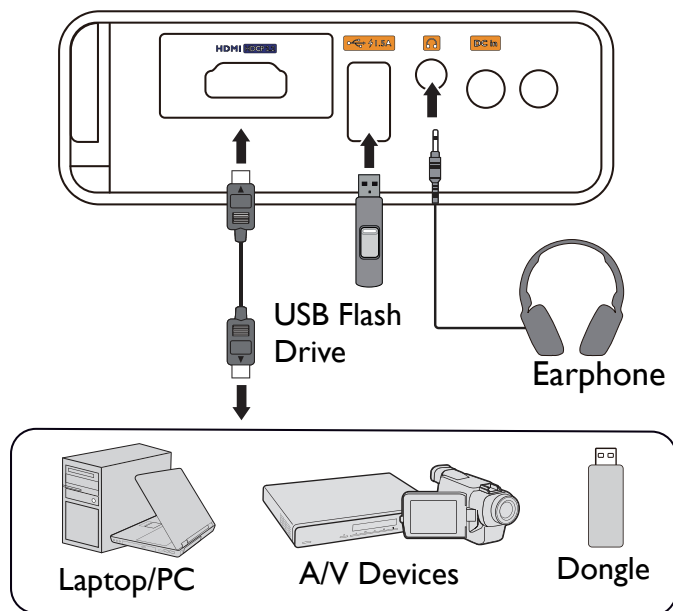

 The illustration above is for reference only.

Wired connections

Connecting a HDMI device

Using an HDMI cable you can connect a device that is equipped with HDMI capabilities to broadcast videos and images on the projector.

To connect a device with HDMI:

1. Connect the device to the HDMI port on the projector.
 2. Select **HDMI** from the source menu. The video from the device will be displayed once the signal from the device is detected.
-

 If no signal is detected or the signal is interrupted a message will appear.

3. If the device remains connected and you want to project its video again press the source button , and then select the corresponding port in the source menu.
-

 Some laptops do not turn on their external video ports when connected to a projector. Usually a key combination like **Fn + F3** or CRT/LCD key turns the external display on/off. Locate a function key labeled CRT/LCD or a function key with a monitor symbol on the laptop. Press **Fn** and the labeled function key simultaneously. Refer to your laptop's documentation to discover your laptop's key combination.

Connecting a dongle

Depending on your need, you can connect a dongle to the projector's HDMI port for different purposes such as Internet access and wireless projection. If needed, the dongle can be powered from the USB port on the projector which provides 1.5V power. Follow the user instructions that come with your dongle to connect and operate the dongle.

 After the dongle is plugged in, the tilt angle of the projector may be affected.

Switching input sources

To switch input sources, press the source button  on the remote control and select the desired input source from the source menu.

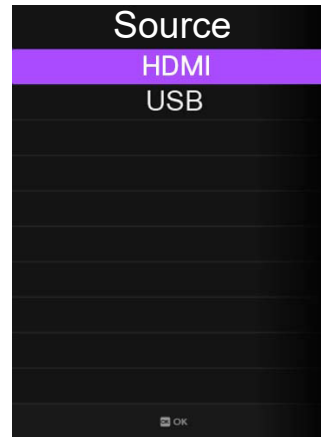

Connecting a USB flash drive

Connect a USB-A drive to the respective port on the projector to play media files stored on the USB flash drive.

To play media files stored on a USB flash drive:

1. Connect the USB flash drive to the USB-A.
2. Select **USB** from the source menu.
3. Select the type of media file you want to play and press **OK**.

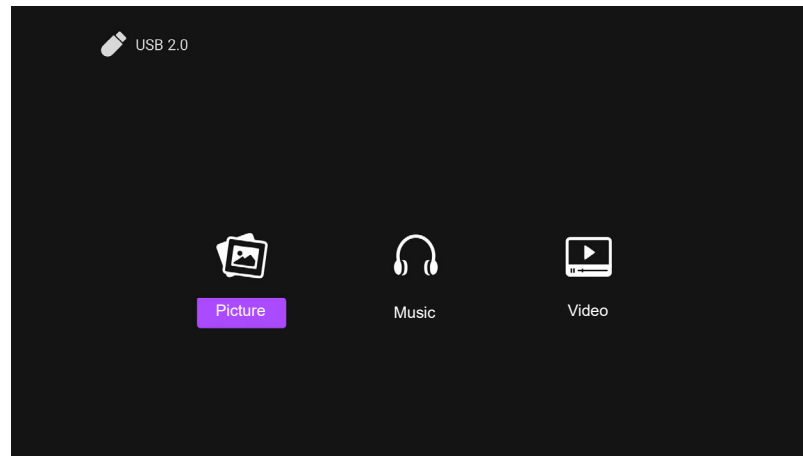

4. Navigate to and select the media file you want play. The projector's media player will launch.

Connecting audio

The projector has built-in mono speaker(s) which are designed to provide basic audio functionality accompanying data presentations for business purposes only. They are not designed for, nor intended for stereo audio reproduction use as might be expected in home theater or home cinema applications. Any stereo audio input (if provided), is mixed into a common mono audio output through the projector speaker(s). The built-in speaker(s) will be muted when the earphone jack is connected.

If you want to keep playing music without projecting an image (i.e. like an MP3 player), select **Audio Only Mode** after pressing the power button  on the remote control.

Navigating the settings menu

About the settings menu

To let you make various adjustments or settings on the projector, the projector provides a **Settings** menu. To access the menu, press the **MENU** button on the remote control.

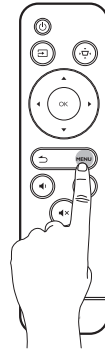

Under the settings menu there are 3 subcategories: **Picture & Sound**, **Installation** and **System**:

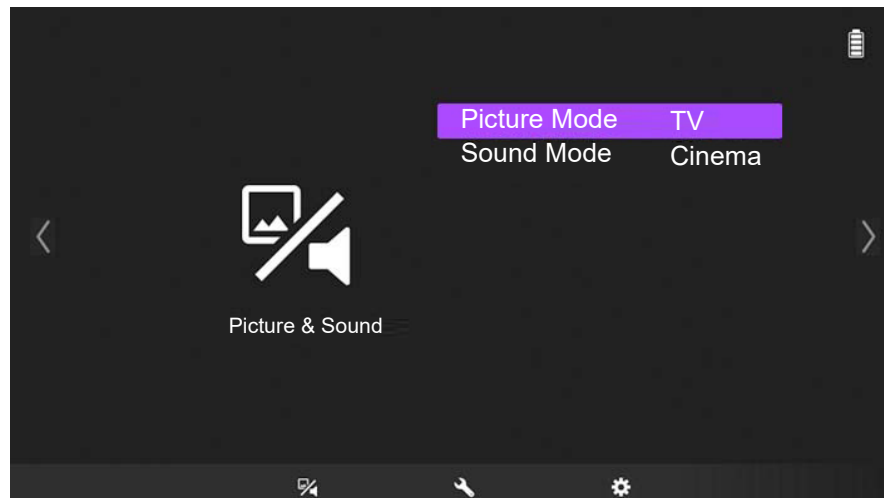

Using the **Settings** menu

To access the various settings menus:

- Use the arrow buttons (◀/▶) to move through the main settings menus.

- Use **OK** to select the desired menu.

When configuring items within a menu:

- Use the up and down arrow buttons (▲/▼) to move to the item you want to configure.

- Use **OK** to select sub-menu options.

- Use the arrow buttons (▲/▼ ◀/▶) to toggle through the available options.

- Use the back button ↶ to return to the main settings menu.

Picture & Sound

The following table describes the items available in the **Picture & Sound** menu:

Item	Options and descriptions
Picture Mode	<ul style="list-style-type: none"> • Bright: Maximizes the brightness of the projected image. This mode is the brightest mode on your projector. • TV: With well-saturated colors and fine-tuned sharpness, this mode is slightly brighter than Cinema mode and suitable for playing TV streaming. • Cinema: With accurate colors and deep contrast at a lower brightness level, this mode is suitable for playing movies. • Game: Picture settings appropriate for playing video games. This mode especially enhances details in dark scenes so that enemies cannot hide. • PC: With accurate RGB colors, this mode provides true-to-life and pure images. It's suitable for viewing photos taken with an sRGB compatible and properly calibrated camera or for viewing PC graphic. <p>For each picture mode, you can adjust the following settings:</p> <ul style="list-style-type: none"> • Brightness: The higher the value, the brighter the image. Adjust this control so the black areas of the image appear just as black and that detail in the dark areas is visible. • Contrast: The higher the value, the greater the contrast. Use this to set the peak white level after you have previously adjusted the Brightness setting to suit your selected input and viewing environment. • Color: Lower setting produces less saturated colors. If the setting is too high, colors on the image will be overpowering, which makes the image unrealistic. • Sharpness: The higher the value, the sharper the picture becomes.
Sound Mode	<p>Sound Mode utilizes sound enhancement technology, which incorporates Waves' algorithms to deliver great effects of the bass and treble and provide you with immersive cinematic audio experience.</p> <ul style="list-style-type: none"> • Cinema: This mode provides cinematic bass sound and enhances mid-high frequencies for balanced background sound and plentiful details. In addition, this mode also enhances vocal clarity so that user could hear clear whispered dialogue and mumbling voices. • Music: This mode allows users to enjoy pop, rock, jazz and classic. The sound field emphasizes the vividness of the singers and the beat of rhythm instruments. • Game: This mode provides dynamic sound field for party game. The spatial sound emphasizes clear chat, footsteps and movement in the various scenes.

Installation

The following table describes the items available in the **Installation** menu:

Item	Options and descriptions
Projector Position	Chooses the position in which the projector is installed. See Choosing a location on page 19 for more details.
Aspect Ratio	<p>There are several options to set the image's aspect ratio depending on your input signal source. Options include:</p> <ul style="list-style-type: none"> • Auto: Scales an image proportionally to fit the projector's native resolution in its horizontal or vertical width. • 4:3: Scales an image so that it is displayed in the center of the screen with a 4:3 aspect ratio. • 16:9: Scales an image so that it is displayed in the center of the screen with a 16:9 aspect ratio.
Keystone Setting	<ul style="list-style-type: none"> • Auto Vertical Keystone: Automatically corrects the keystone at the top/bottom side of the projected image. • Vertical Keystone Correction: See Correcting keystone on page 26 for more details.
HDMI Format	<p>Allows you to further configure HDMI settings</p> <ul style="list-style-type: none"> • Auto: Automatically selects a suitable color range for the incoming HDMI signal. • RGB Full: Utilizes the Full range RGB 0-255. • RGB Limited: Utilizes the Limited range RGB 16-235.
Eco Mode	This setting reduces system noise and power consumption by 30%. If Eco Mode is selected, the light output will be reduced.
High Altitude Mode	<p>We recommend you use the High Altitude Mode when your environment is between 1500 m - 2000 m above sea level, and ambient temperature is between 0°C to 30°C.</p> <p>Operation under High Altitude Mode may cause a higher decibel operating noise level because of increased fan speed necessary to improve overall system cooling and performance.</p> <p>If you use this projector under other extreme conditions excluding the above, it may display auto shut-down symptoms, which is designed to protect your projector from over-heating. In cases like this, you should switch to High Altitude Mode to solve these symptoms. However, this is not to state that this projector can operate under any and all harsh or extreme conditions.</p> <p> Do not use the High Altitude Mode if your altitude is between 0 m and 1500 m and ambient temperature is between 0°C to 35°C. The projector will be over cooled, if you turn the mode on under such a condition.</p>

System

The following table describes the items available in the **System** menu:

Item	Options and descriptions
Language	Sets the language for the projector.
Projector Information	Displays information on the current status of the projector including the current Device Name , Detected Resolution , Picture Mode , Power Mode and Firmware Version .  See Updating firmware on page 35 on how to update the projector's firmware.
Factory Reset	Returns the projector to its factory default state.

Updating firmware

1. Copy firmware file “BenQ_GV10_USB.bin” to the root directory of a FAT32 formatted USB flash drive.
2. Plug in the USB flash drive to the USB-A port on the projector.
3. Plug in the AC adapter.
4. Use ◀Left, ▶Right on the remote control to select the **System** menu and press **OK**.
5. Use ▲Up, ▼Down on the remote control to select **Projector Information**.
6. Highlight **Firmware Version** and press **OK**. A message “**Are you sure to update FW?**” will appear.
7. Select “**Yes**” to start the firmware update progress.

Maintenance

Care of the projector

Your projector needs little maintenance. The only thing you have to do on a regular basis is keep the lens clean.

Never remove any parts of the projector. Contact your dealer or local customer service center if the projector fails to operate as expected.

Cleaning the lens

Clean the lens whenever you notice dirt or dust on the surface.

Before cleaning any part of the projector, turn it off using the proper shutdown procedure (see [Shutting down the projector on page 23](#)), unplug the power cable, and let it cool down completely.

- Use a canister of compressed air to remove dust.
- If there is dirt or smears, use lens-cleaning paper or moisten a soft cloth with lens cleaner and gently wipe the lens surface.
- Never use any type of abrasive pad, alkaline/acid cleaner, scouring powder, or volatile solvent, such as alcohol, benzene, thinner or insecticide. Using such materials or maintaining prolonged contact with rubber or vinyl materials may result in damage to the projector surface and cabinet material.

 Never touch the lens with your finger or rub the lens with abrasive materials. Even paper towels can damage the lens coating. Only ever use a proper photographic lens brush, cloth, and cleaning solution. Do not attempt to clean the lens while the projector is switched on or is still hot from previous use.

Storing the projector

To store the projector for an extended time:

- Make sure the temperature and humidity of the storage area are within the recommended range for the projector. Refer to [Specifications \(page 40\)](#) or consult your dealer about the range.
- Retract the adjuster feet.
- Remove the batteries from the remote control.
- Pack the projector in its original packing or equivalent.

Transporting the projector

It is recommended that you ship the projector with its original packing or equivalent.

Extending LED life

The LED headlight includes a bulb which features a light-source life far beyond traditional bulbs, yet it is still a consumable item. To keep the LED life as long as possible, you can change the following settings via the settings menu.

To access the settings menu, see [Using the Settings menu on page 32](#) for details.

Setting LED Mode

Set the projector **Eco Mode** to **On** to extend the LED life.

LED mode	Description
Eco Mode: Off	100% LED brightness.
Eco Mode: On	This setting reduces system noise and power consumption by 30%. If Eco Mode is selected, the light output will be reduced.

1. Press the **MENU** button on the remote control.
2. Press (◀/▶) to select **Installation**.
3. Press (▲/▼) to select **Eco Mode**.
4. Press **OK** to choose between **On** and **Off**.
5. When done, press ↵ to save your changes and exit.

Troubleshooting

If your problems remain after checking this manual, please contact your place of purchase or visit the local website from Support.BenQ.com for more support and local customer service.



Support.BenQ.com

Problem	Cause	Remedy
The projector does not turn on.	There is no power from the power cable.	Plug the power cable into the AC inlet on the rear of the projector, and plug the power cable into to the power outlet. If the power outlet has a switch, make sure that it is switched on.
	The battery is running out and in low voltage.	Plug in power adapter to charge the projector until the LED indicator turns off; then push the projector's power switch on or press the power button on the remote control to turn it on.
The projector cannot play files in USB flash drives via USB-A ports.	The USB flash drive is not connected to the projector properly.	Make sure your USB flash drive is fully inserted into the USB-A port on the projector.
	The projector does not support the file formats.	See Supported file formats on page 45 for more information about file formats supported by the projector.
Screen brightness is changed.	The adapter is removed.	The light brightness is decreased in Eco Mode to support longer projection. If a brighter screen is preferred, connect the power adapter to the projector or change the Eco Mode to Off .
	The adapter is not removed but the Eco Mode is switched on.	

Problem	Cause	Remedy
No input source.	The video source is not turned on or connected correctly.	Turn the video source on and check that the signal cable is connected correctly.
	The projector is not correctly connected to the input source device.	Check the connection.
	The video or audio file format is not supported by the projector.	Make sure the supported file format as described in Supported file formats on page 45 is being played, or contact the customer service for assistance.
Image or audio is unstable.	The connection cables are not securely connected to the projector or the signal source.	Correctly connect the cables to the appropriate terminals.
Picture is blurred.	The projection lens is not correctly focused.	Adjust the focus ring.
	The projector and the screen are not aligned properly.	Adjust the projection angle and direction as well as the height of this projector if necessary.
Remote control does not work correctly.	The batteries are out of power.	Replace both of the batteries with new ones.
	There is an obstacle between the remote control and the projector.	Remove the obstacle.
	You are too far away from the projector.	Stand within 8 meters (26.2 feet) of the projector.

Specifications

Projector specifications



All specifications are subject to change without notice.

Specifications	
Projection System	DLP
DMD Type	0.2"
Native Resolution	854 x 480 pixels
Brightness	100 ANSI Lumens
Contrast Ratio	400:1 (typical)
Display Color	24 Bits (16.7 Million Colors)
Aspect Ratio	16:9
Light Source	LED
Light Source Life⁽¹⁾	20,000 hours (Normal) / 30,000 hours (Eco)
Throw Ratio	1.3 (35"@1M)
Zoom Ratio	Fixed
Keystone Correction	Auto Vertical Keystone \pm 40 degrees Manual Vertical Keystone \pm 40 degrees
Projection Offset	100%
Projection Size	30 to 100 inches

Specifications		
Interface	<ul style="list-style-type: none"> • USB-A (2.0)(5V/2.0A/Reader) x 1 • HDMI v1.4 x 1 • 3.5mm mini jack (Headphone out) x 1 	
Power	DC Supply	
	Frequency	AC 100 to 240V 50/60HZ 1.5A
	Power Rating	12V/3.33A
	Battery Life	
	Type	Lithium-ion battery
	Electrical Rating	7.3V 2480 mAh
	Battery Cycle Life	300 cycles
	Battery Life	1.3 hours (under Normal mode); 2 hours (under ECO mode without loading)
Built-in Speaker	3W x 1	
Resolution Support	HDMI: VGA (640 x 480) to Full HD (1920 x 1080)	
Horizontal Frequency	15.63 to 79.976 KHz	
Vertical Scan Rate	23.98 to 75.028 Hz	
HDTV Compatibility	480i, 480p, 576i, 576p, 720p, 1080i, 1080p	



LED life results will vary depending on environmental conditions and usage.

Timing chart

Supported timing for video input

Mode	Refresh Rate (Hz)	H. Frequency (KHz)	Dot Clock Frequency (MHz)
480i	60	15.73	27.000
480p	59.939	31.48	27
576i	50	15.63	27.000
576p	50	31.25	27.000
720p_60	60	45.00	74.25
720p_50	50	37.50	74.25
1080i_60	60	33.75	74.25
1080i_50	50	28.13	74.25
1080p	60	67.5	148.5
1080p	50	56.26	148.5
1080p	24	27.00	74.25
1080p	23.98	26.97	74.175



Supported by HDMI 2.0 only.

Supported timing for PC input

Resolution	Mode	Refresh Rate (Hz)	H. Frequency (KHz)	Dot Clock Frequency (MHz)
640 x 480	VGA_60	59.939	31.468	25.175
	VGA_72	72.808	37.860	31.500
	VGA_75	75.000	37.500	31.500
800 x 600	SVGA_56	56.250	35.156	36.000
	SVGA_60	60.315	37.878	40.000
	SVGA_72	72.186	48.076	50.000
	SVGA_75	75.000	46.875	49.500
848 x 480	848 x 480_60	60.000	60.000	33.750
1024 x 768	XGA_60	60.004	48.363	65.000
	XGA_70	70.069	56.476	75.000
	XGA_75	75.028	60.022	78.750
1152 x 864	SXGA_70	70.000	63.000	96.768
	SXGA_75	75.000	67.500	108.000
1280 x 1024	SXGA_60	60.020	63.981	108.000
	SXGA_72	71.990	77.893	134.600
	SXGA_75	75.024	79.976	135.000
1280 x 960	QuadVGA_60	60.000	60.000	108.000
1280 x 960	QuadVGA_75	75.000	75.000	126.000
1400 x 1050	SXGA+_60	59.978	65.316	121.750

Resolution	Mode	Refresh Rate (Hz)	H. Frequency (KHz)	Dot Clock Frequency (MHz)
1600 x 1200	UXGA_60	60.000	75.000	162.000
1280 x 768	WXGA_60	59.870	47.776	79.500
	WXGA_75	74.892	60.288	102.250
1280 x 720	WXGA_60	60.000	45.000	74.250
1280 x 800	WXGA_60	59.810	49.702	83.500
1440 x 900	WXGA+_60	59.887	55.934	106.500
1680 x 1050	1680 x 1050_60	59.954	65.290	146.250
1366 x 768	1366 x 768_60	59.789	47.712	85.500
1920 x 1080	1920 x 1080	60	67.5	148.5

 The timings showing above may not be supported for due to EDID file and VGA graphic card limitations. It is possible that some timings cannot be chosen.

Supported file formats

File type	File extension
Documents	N/A
Photos	JPG(.jpg, .jpeg), PNG(.png), BMP(.bmp), GIF(.gif)
Music	MP3(.mp3), WAV(.wav), FLAC(.flac)
Video	MPEG program stream (.mpg, .mpeg, mp4) MOV(.mov) FLV(.flv) MPEG transport stream (.ts) ASF(.asf) WMV(.wmv) AVI(.avi) MKV(.mkv)
Subtitles	N/A



Bit rate range: If the peak bit rate of a video file is larger than 10MB, it might cause video playback lag.

Appendix

Installing the projector on a tripod (purchased separately)

Use a tripod plate to mount the projector onto a tripod:

1. Install the tripod's quick release plate to the projector's tripod screw hole and tighten the plate's screw. (Tripod screw size: M6)

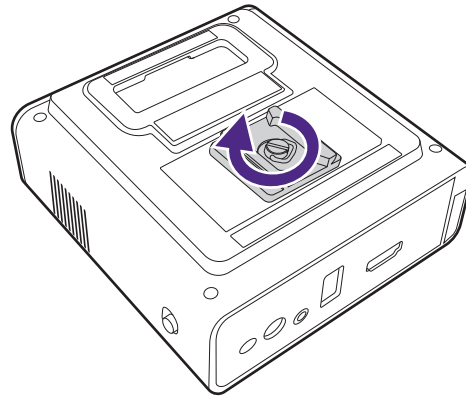

2. Install the projector onto the tripod.

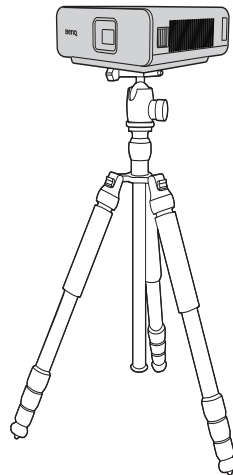

Copyright and disclaimer

Copyright

Copyright © 2022 by BenQ Corporation. All rights reserved. No part of this publication may be reproduced, transmitted, transcribed, stored in a retrieval system or translated into any language or computer language, in any form or by any means, electronic, mechanical, magnetic, optical, chemical, manual or otherwise, without the prior written permission of BenQ Corporation.

All other logos, products, or company names mentioned in this manual may be the registered trademarks or copyrights of their respective companies, and are used for informational purposes only.

Disclaimer

BenQ Corporation makes no representations or warranties, either expressed or implied, with respect to the contents hereof and specifically disclaims any warranties, merchantability or fitness for any particular purpose. Further, BenQ Corporation reserves the right to revise this publication and to make changes from time to time in the contents hereof without obligation of BenQ Corporation to notify any person of such revision or changes. This user manual aims to provide the most updated and accurate information to customers, and thus all contents may be modified from time to time without prior notice. Please visit <http://www.benq.com> for the latest version of this manual.

Warranty

BenQ warrants this product against any defects in material and workmanship, under normal usage and storage.

Proof of purchase date will be required with any warranty claim. In the event this product is found to be defective within the warranty period, BenQ's only obligation and your exclusive remedy shall be replacement of any defective parts (labor included). To obtain warranty service, immediately notify the dealer from which you purchased the product of any defects.

Important: The above warranty shall be void if the customer fails to operate the product in accordance with BenQ's written instructions, especially the ambient humidity must be in-between 10% and 90%, temperature in-between 0°C and 40°C, altitude lower than 2000 meters, and avoiding to operate the projector in a dusty environment. This warranty gives you specific legal rights, and you may have other rights which vary from country to country.

For other information, please visit www.BenQ.com.

Statement regarding hyperlinks and third-party websites

BenQ is not responsible for the content of the websites or of similar resources, which are maintained and controlled by third parties, that may be linked from this product. Providing links to those websites or to similar resources does not mean that BenQ makes any warranty or representation to their content by expression or by implication.

Any third party content or service preinstalled in this product is provided “as is”. BenQ does not, by expression or by implication, make any warrant to the content or to the services provided by third parties. BenQ does not warrant or guarantee that the content or services provided by third parties are accurate, effective, most up-to-date, legal, or complete. Under no circumstances shall BenQ be liable for the content or services provided by third parties including their negligence.

Services provided by third parties may be terminated temporarily or permanently. BenQ does not warrant or guarantee that any content or services provided by third parties are in good condition at any time, and is not liable for the termination of the said content and services.

In addition, BenQ is not involved in any transactions you conduct in the websites or similar resources maintained by third parties.

You should contact the content or service providers for any questions, concerns, or disputes.